

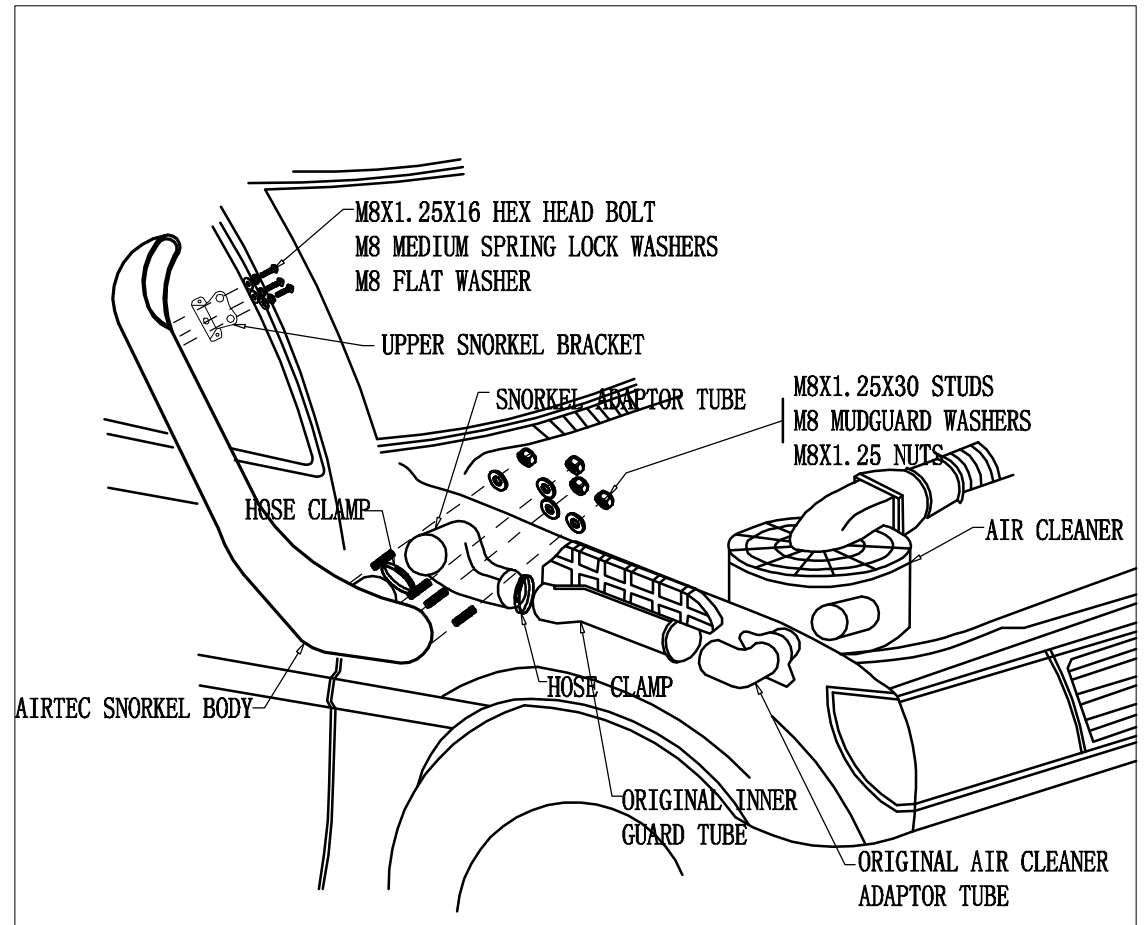

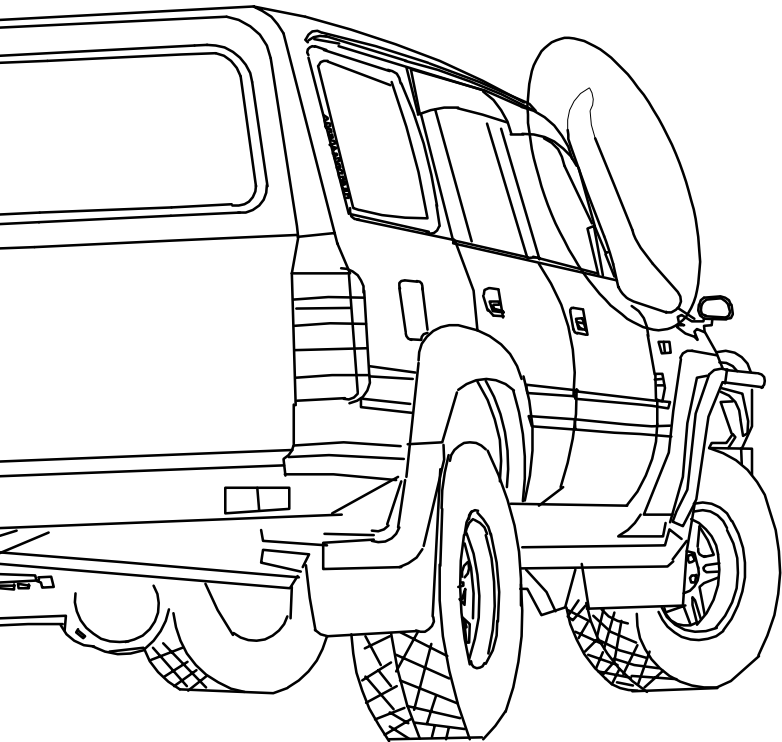











HD007100A1-FJ100 SNORKEL

Installation Instruction



Parts list:

 AIRTEC SNORKEL BODY (1 PIECE)	 SNORKEL ADAPTOR TUBE (1 PIECE)	 $\varnothing 71-95$ $\varnothing 103-127$ HOSE CLAMP (2 piece)	 M8X30 STUDS (4 PIECES)	 M8 NUTS (4 PIECES)	 M8/ $\varnothing 30 \times \varnothing 8.5 \times 2$ M8 MUDGUARD WASHERS (4 PIECES)
 UPPER SNORKEL BRACKET (1 PIECE)	 M8X16 HEX HEAD BOLT (3 PIECE)	 M8 MEDIUM SPRING LOCK WASHERS (7 PIECES)	 M8/ $\varnothing 16 \times \varnothing 8.5 \times 1$ M8 FLAT WASHER (3 PIECES)	 M4X20 PK SCREWS (2 PIECES)	 PLASTIC INSERTS (2 PIECES)
 inside diameter $\varnothing 2 \times 400$ (mm) Plastics (1 piece)					